



Luminaire LumaShine Series Track Head offers specification grade beam performance. LumaShine Track Heads are positioned closer to the ceiling for a cleaner look and design with a sleek, integrated hinge and internal driver for a contemporary appearance. AccuRender technology provides the highest color quality at the highest efficacy. Made with renewable materials, the LumaShine Series offers a range of color, beam, lumen, and temperature options, and is ideal in retail, hospitality, and office environments.

This portfolio of luminaires is powered by myCreation, Genlyte's advanced additive manufacturing technology that enables rapid production of high-quality, customizable luminaires. It streamlines design-to-delivery with on-demand colors, textures, and configurations—while reducing components and using 3D-printed parts made from at least 75% recycled or mass-balanced, bio-circular materials.

Project: _____
 Location: _____
 Cat.No: _____
 Type: _____
 Qty: _____
 Notes: _____

Fixture

Now including AccuRender technology for the highest color quality at the highest efficacy.

example: 3DTHSN M L WHST LF 15L RF 30K

Series	Size	Adapters	Housing Colors	Textures	Lumens	Reflector / Beam Spreads	CRI / CCT
3DTHSN	M			LF			
3DTHSN LumaShine Series	M Medium	L Lightolier J Juno H Halo	Satin Essentials BKST Black GYST Grey WHST White	LF Layered Fine	10L 1000lm 15L 1500lm 23L 2300lm	RS Spot (17°) RNF Narrow Flood (22°) RF Flood (34°) RWF Wide Flood (60°)	27K 90 CRI / 2700K 30K 90 CRI / 3000K 35K 90 CRI / 3500K 40K 90 CRI / 4000K

Note:

Features

- Customizable:** Choose from a wide variety of configurations.
- Sustainable:** 3D-Printed products produce less carbon emissions when compared to traditional, conventional luminaires.
- Local production:** Printed and assembled in Littlestown, PA.
- Quick delivery:** Created on demand and shipped in weeks.
- Lifetime:** L90/B50 Lumen Maintenance at 66,000 hours and L70/B50 >110,000 hours.

Dimming Compatibility

Trailing edge (ELV) dimming compatible
SELV-300P Lutron Skylark (100-7%)
DVELV-300P Lutron Diva (100-7%)
6615-P Leviton Decora (100-12%)

Electrical

Efficacy: Up to 128 lm/W
Track Mount: Standard Lightolier track adapter
Input Voltage: 120V
Frequency: 50/60Hz
Power Factor: 0.9
Control: ELV dimming

Mounting

Track Adapters: Lightolier, Juno or Halo mounting track options
Horizontal rotation: 350°
Vertical tilt: 90°

Labels

cULus listed, 5 year warranty, IP20, RoHS & DLC Premium rated
 Declare LBC Red List Approved
 (View full Declare label)

Buy American Act 1933 (BAA)

This product is manufactured in one of our US factories and, as of the date of this document, this product was considered a commercially available off-the-shelf (COTS) item meeting the requirements of the BAA. This BAA designation hereunder does not address (i) the applicability of, or availability of a waiver under, the Trade Agreements Act, or (ii) the "Buy America" domestic content requirements imposed on states, localities, and other non-federal entities as a condition of receiving funds administered by the Department of Transportation or other federal agencies. Prior to ordering, please visit www.signify.com/baa to view a current list of BAA-compliant products to confirm this product's current compliance.

Interact for intelligent buildings

Interact for intelligent buildings with its simple wireless offering can make your smart building journey easy and cost effective. This system can help you boost your energy savings, reach your sustainability targets, and enhance occupancy comfort levels immediately from day one. 3D-printed luminaires can be integrated into the Interact for intelligent buildings system using the System Bridge Accessory SBA module or the RFSR10 control module. For more information please visit: <https://www.genlyte.com/en-us/brands/signify-interact/interact-for-intelligent-buildings>



Unleash your inner creator

To configure your LumaShine Series luminaire, scan the QR Code or visit us at: <https://www.3dconfigurator.mycreation.signify.com/lightolier/TCLSN1>



LumaShine Series

3D Track Heads (1000lm, 1500lm, 2300lm)

AccuRender Technology (CRI 90+)

The right light brings colors to life. Our new AccuRender technology helps ensure colors are rendered more accurately and consistently, while doing so as efficiently as CRI 80 products.



Standard CRI 80

Good color rendering and high efficacy



Standard CRI 90

Better color rendering and low efficacy



AccuRender

Best color rendering, color preference and high efficacy

Promote savings

High efficacy, with no penalty:

- Energy efficacy compares well to conventional CRI 80
- Up to 25% more energy savings vs competitor CRI 90¹
- Helps you meet Title 24 requirements

Enjoy design flexibility

Full range of products and options:

- Available soon across Lightolier portfolio for application flexibility
- Multiple CCTs and lumen packages offered

1. Based on comparison of published specification sheet data, most competitor offerings reflect a 15 to 25% efficacy loss for CRI 90 compared to CRI 80, while Lightolier AccuRender results in only $\leq 5\%$ drop compared to CRI 80.

Bolster wellbeing

High MDER:

- AccuRender has a Melanopic Daylight Efficacy Ratio up to 0.80
- Helps support Circadian Rhythm²
- Earns points towards WELL Building Standard

Contribute to productivity

High MDER:

- Supports daytime vitality³ and alertness⁴
- Supports mood, thermo-regulation, and learning centers in the brain⁵
- May positively influence work engagement by helping make the environment more attractive⁶

2. Czeisler, 1999; Dijk & Archer, 2009; Lucas 2012, 2019

3. Partonen 2000

4. Viola 2008, Smolders 2012; Geerdink 2017

5. Fernandez 2018; Rupp, 2019

Show your true colors

High color rendering:

- **CRI:**
R_a up to 94, R₉ up to 67, G_a up to 99, C₉ up to 94
- **TM-30:**
R_t up to 92, R_{f,hi} up to 91, R_g up to 100, R_{cs,hi} up to -5%
- **True to life colors** to help energize your environment and render better flesh tones critical for Healthcare, Hospitality and Retail

Achieve color balance

Best in class color consistency:

- ≤ 2 SDCM promotes aesthetic harmony

6. Veitch, Jennifer & Stokkermans, Mariska & R. Newsham, Guy. (2013). Linking Lighting Appraisals to Work Behaviors. Environment and Behavior. 45. 198-214. 10.1177/0013916511420560.

LumaShine Series

3D Track Heads (1000lm, 1500lm, 2300lm)

Colors

Housing Color
BKST Black

Housing Color
GYST Grey

Housing Color
WHST White



Dimensions

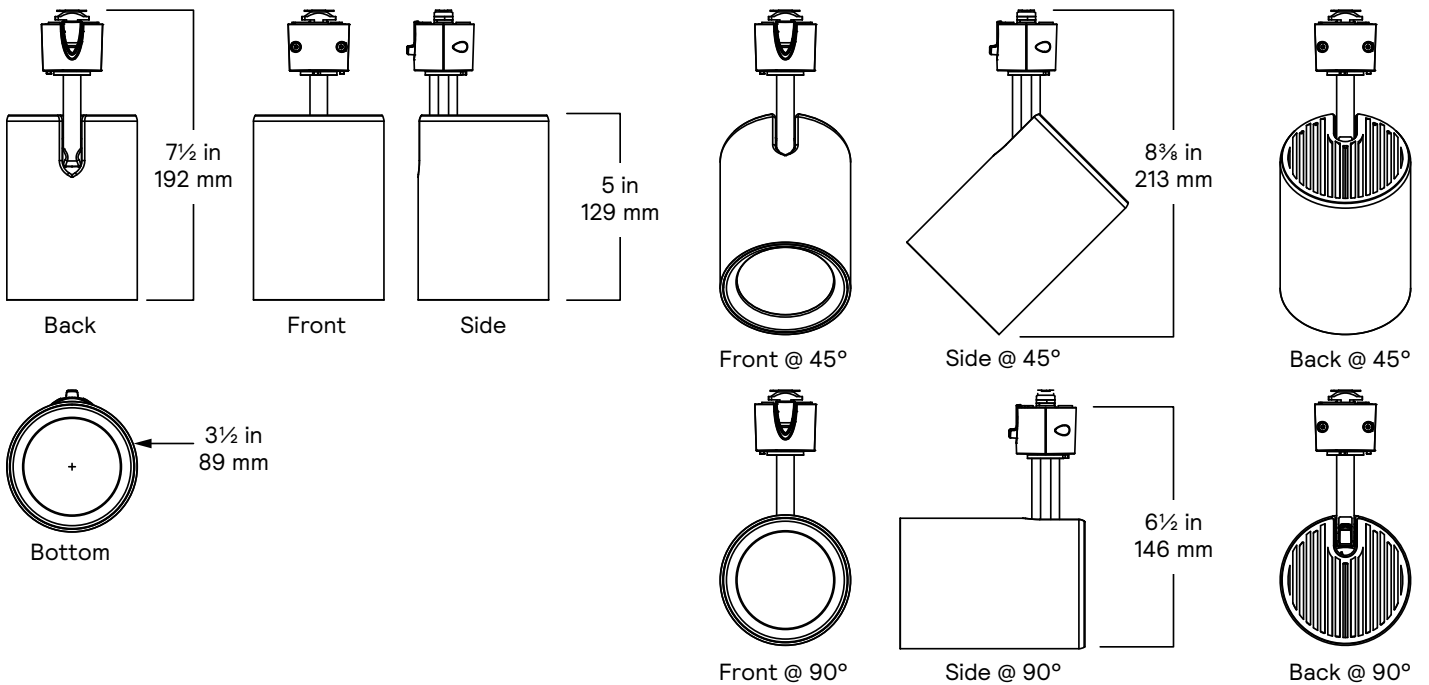

LumaShine Series

3D Track Heads (1000lm)

Aiming Angles

L and W are the outer points where the candle power drops to 50% of the maximum. FC are the initial footcandles at the center of the beam. Data shown is for 3000K, use the table on the right for CRI/CCT adjustment factors.

D Distance
L Beam length
W Beam Width
A Aiming Angle
C Distance to center beam
FC Footcandles
CBCP Center Beam Candlepower

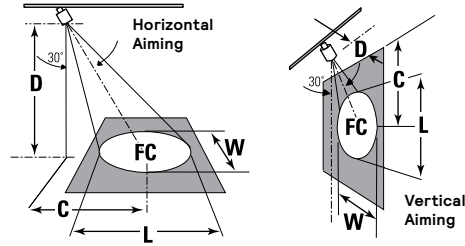

Adjustment factors

2700K:	0.95
3000K:	1
3500K:	1.02
4000K:	1.04

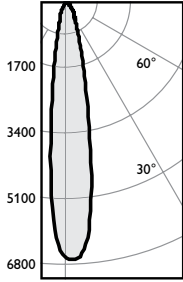

Spot (RS)

3DTHL RS 3.0 930 1000lm

CCT ¹ :	3000K
Output lumens:	1125 lms
Input watts ² :	8.8 W
Efficacy:	127.8 lm/w
CRI:	90 min
CBCP:	7,048 cd

Beam Angle: 17°
Cat No: 1000

30° Aiming Angle

Horizontal Illuminance on floor

D	C	F.C.	L	W
6	3.5	127	2.4	2.1
8	4.6	72	3.2	2.8
10	5.8	46	4.0	3.5
12	6.9	32	4.8	4.1

30° Aiming Angle

Vertical Illuminance on floor

D	C	F.C.	L	W
2	3.5	220	2.6	1.2
3	5.2	98	3.8	1.8
4	6.9	55	5.1	2.4
5	8.7	35	6.4	3.0

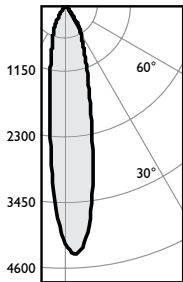

Narrow Flood (RNF)

3DTHL RNF 3.0 930 1000lm

CCT ¹ :	3000K
Output lumens:	1109 lms
Input watts ² :	8.8 W
Efficacy:	126.0 lm/w
CRI:	90 min
CBCP:	4,442 cd

Beam Angle: 20°
Cat No: 1000

30° Aiming Angle

Horizontal Illuminance on floor

D	C	F.C.	L	W
6	3.5	80	2.9	2.4
8	4.6	45	3.8	3.3
10	5.8	29	4.8	4.1
12	6.9	20	5.7	4.9

30° Aiming Angle

Vertical Illuminance on floor

D	C	F.C.	L	W
2	3.5	139	3.1	1.4
3	5.2	62	4.7	2.1
4	6.9	35	6.2	2.8
5	8.7	22	7.8	3.5

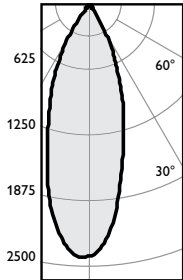

Medium Flood (RMF)

3DTHL RF 3.0 930 1000lm

CCT ¹ :	3000K
Output lumens:	1085 lms
Input watts ² :	8.8 W
Efficacy:	123.3 lm/w
CRI:	90 min
CBCP:	2,553 cd

Beam Angle: 35°
Cat No: 1000

30° Aiming Angle

Horizontal Illuminance on floor

D	C	F.C.	L	W
6	3.5	46	5.2	4.4
8	4.6	26	7.0	5.8
10	5.8	17	8.7	7.3
12	6.9	12	10.4	8.7

30° Aiming Angle

Vertical Illuminance on floor

D	C	F.C.	L	W
2	3.5	80	7.2	2.5
3	5.2	35	10.8	3.8
4	6.9	20	14.4	5.0
5	8.7	13	18.0	6.3

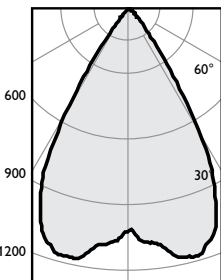

Flood (RWF)

3DTHL RWF 3.0 930 1000lm

CCT ¹ :	3000K
Output lumens:	1118 lms
Input watts ² :	8.8 W
Efficacy:	127.0 lm/w
CRI:	90 min
CBCP:	1,083 cd

Beam Angle: 59°
Cat No: 1000

30° Aiming Angle

Horizontal Illuminance on floor

D	C	F.C.	L	W
6	3.5	20	10.1	7.8
8	4.6	11	13.5	10.5
10	5.8	7	16.9	13.1
12	6.9	5	20.3	15.7

30° Aiming Angle

Vertical Illuminance on floor

D	C	F.C.	L	W
2	3.5	34	228.0	4.5
3	5.2	15	342.0	6.8
4	6.9	8	456.0	9.1
5	8.7	5	570.0	11.3

1. Correlated Color Temperature within specs as defined in ANSI_NEMA_ANSLG C78.377-2008: Specifications for the Chromaticity of Solid State Lighting Products.

2. Wattage controlled to within +/- 5%.

Note: Tested using absolute photometry as specified in LM79: IESNA Approved Method for the Electrical and Photometric Measurements of Solid-State Lighting Products.

LumaShine Series

3D Track Heads (1500lm)

Aiming Angles

L and W are the outer points where the candle power drops to 50% of the maximum. FC are the initial footcandles at the center of the beam. Data shown is for 3000K, use the table on the right for CRI/CCT adjustment factors.

D Distance
L Beam length
W Beam Width
A Aiming Angle
C Distance to center beam
FC Footcandles
CBCP Center Beam Candlepower

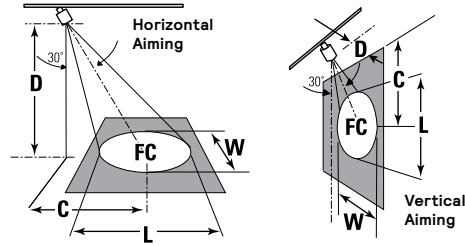

Adjustment factors

2700K:	0.95
3000K:	1
3500K:	1.02
4000K:	1.04

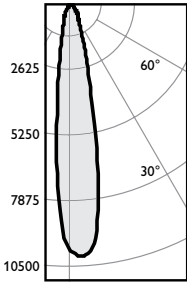

Spot (RS)

3DTHL RS 3.0 930 1500lm

CCT ¹ :	3000K
Output lumens:	1665 lms
Input watts ² :	13.4 W
Efficacy:	124.3 lm/w
CRI:	90 min
CBCP:	10,426 cd

Beam Angle: 17°
Cat No: 1500

30° Aiming Angle

Horizontal Illuminance on floor

D	C	F.C.	L	W
6	3.5	188	2.4	2.1
8	4.6	106	3.2	2.8
10	5.8	68	4.0	3.5
12	6.9	47	4.8	4.1

30° Aiming Angle

Vertical Illuminance on floor

D	C	F.C.	L	W
2	3.5	326	2.6	1.2
3	5.2	145	3.8	1.8
4	6.9	81	5.1	2.4
5	8.7	52	6.4	3.0

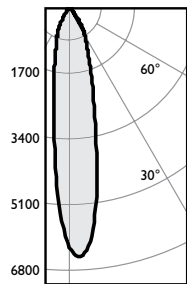

Narrow Flood (RNF)

3DTHL RNF 3.0 930 1500lm

CCT ¹ :	3000K
Output lumens:	1641 lms
Input watts ² :	13.4 W
Efficacy:	122.5 lm/w
CRI:	90 min
CBCP:	6,571 cd

Beam Angle: 20°
Cat No: 1500

30° Aiming Angle

Horizontal Illuminance on floor

D	C	F.C.	L	W
6	3.5	119	2.9	2.4
8	4.6	67	3.8	3.3
10	5.8	43	4.8	4.1
12	6.9	30	5.7	4.9

30° Aiming Angle

Vertical Illuminance on floor

D	C	F.C.	L	W
2	3.5	205	3.1	1.4
3	5.2	91	4.7	2.1
4	6.9	51	6.2	2.8
5	8.7	33	7.8	3.5

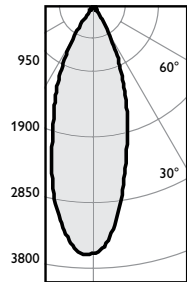

Medium Flood (RMF)

3DTHL RF 3.0 930 1500lm

CCT ¹ :	3000K
Output lumens:	1654 lms
Input watts ² :	13.4 W
Efficacy:	123.4 lm/w
CRI:	90 min
CBCP:	3,776 cd

Beam Angle: 35°
Cat No: 1500

30° Aiming Angle

Horizontal Illuminance on floor

D	C	F.C.	L	W
6	3.5	68	5.2	4.4
8	4.6	38	7.0	5.8
10	5.8	25	8.7	7.3
12	6.9	17	10.4	8.7

30° Aiming Angle

Vertical Illuminance on floor

D	C	F.C.	L	W
2	3.5	118	7.2	2.5
3	5.2	52	10.8	3.8
4	6.9	30	14.4	5.0
5	8.7	19	18.0	6.3

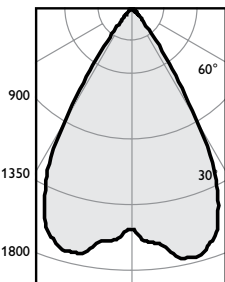

Flood (RWF)

3DTHL RWF 3.0 930 1500lm

CCT ¹ :	3000K
Output lumens:	1605 lms
Input watts ² :	13.4 W
Efficacy:	119.8 lm/w
CRI:	90 min
CBCP:	1,602 cd

Beam Angle: 59°
Cat No: 1500

30° Aiming Angle

Horizontal Illuminance on floor

D	C	F.C.	L	W
6	3.5	29	10.1	7.8
8	4.6	16	13.5	10.5
10	5.8	10	16.9	13.1
12	6.9	7	20.3	15.7

30° Aiming Angle

Vertical Illuminance on floor

D	C	F.C.	L	W
2	3.5	50	228.0	4.5
3	5.2	22	342.0	6.8
4	6.9	13	456.0	9.1
5	8.7	8	570.0	11.3

1. Correlated Color Temperature within specs as defined in ANSI_NEMA_ANSI C78.377-2008: Specifications for the Chromaticity of Solid State Lighting Products.

2. Wattage controlled to within +/- 5%.

Note: Tested using absolute photometry as specified in LM79: IESNA Approved Method for the Electrical and Photometric Measurements of Solid-State Lighting Products.

LumaShine Series

3D Track Heads (2300lm)

Aiming Angles

L and W are the outer points where the candle power drops to 50% of the maximum. FC are the initial footcandles at the center of the beam. Data shown is for 3000K, use the table on the right for CRI/CCT adjustment factors.

D Distance
L Beam length
W Beam Width
A Aiming Angle
C Distance to center beam
FC Footcandles
CBCP Center Beam Candlepower

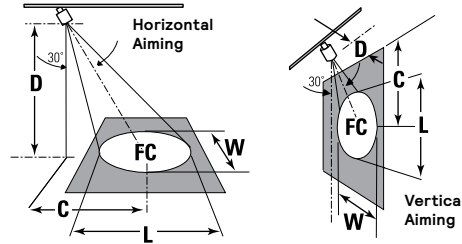

Adjustment factors

2700K:	0.95
3000K:	1
3500K:	1.02
4000K:	1.04

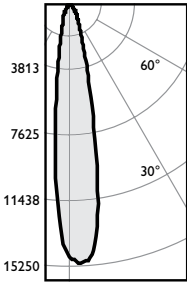

Spot (RS)

3DTHL RS 3.0 930 2300lm

CCT ¹ :	3000K
Output lumens:	2509 lms
Input watts ² :	19.6 W
Efficacy:	128.0 lm/w
CRI:	90 min
CBCP:	17,713 cd

Beam Angle: 17°
Cat No: 2300

30° Aiming Angle

Horizontal Illuminance on floor

D	C	F.C.	L	W
6	3.5	320	2.4	2.1
8	4.6	180	3.2	2.8
10	5.8	115	4.0	3.5
12	6.9	80	4.8	4.1

30° Aiming Angle

Vertical Illuminance on floor

D	C	F.C.	L	W
2	3.5	554	2.6	1.2
3	5.2	246	3.8	1.8
4	6.9	138	5.1	2.4
5	8.7	89	6.4	3.0

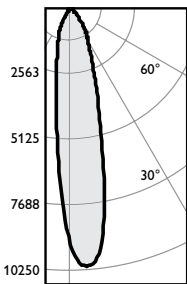

Narrow Flood (RNF)

3DTHL RNF 3.0 930 2300lm

CCT ¹ :	3000K
Output lumens:	2473 lms
Input watts ² :	19.6 W
Efficacy:	126.2 lm/w
CRI:	90 min
CBCP:	9,903 cd

Beam Angle: 20°
Cat No: 2300

30° Aiming Angle

Horizontal Illuminance on floor

D	C	F.C.	L	W
6	3.5	179	2.9	2.4
8	4.6	101	3.8	3.3
10	5.8	64	4.8	4.1
12	6.9	45	5.7	4.9

30° Aiming Angle

Vertical Illuminance on floor

D	C	F.C.	L	W
2	3.5	309	3.1	1.4
3	5.2	138	4.7	2.1
4	6.9	77	6.2	2.8
5	8.7	50	7.8	3.5

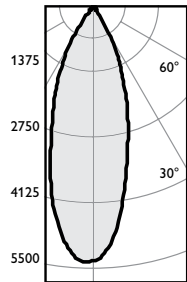

Medium Flood (RMF)

3DTHL RF 3.0 930 2300lm

CCT ¹ :	3000K
Output lumens:	2419 lms
Input watts ² :	19.6 W
Efficacy:	123.4 lm/w
CRI:	90 min
CBCP:	5,690 cd

Beam Angle: 35°
Cat No: 2300

30° Aiming Angle

Horizontal Illuminance on floor

D	C	F.C.	L	W
6	3.5	103	5.2	4.4
8	4.6	58	7.0	5.8
10	5.8	37	8.7	7.3
12	6.9	26	10.4	8.7

30° Aiming Angle

Vertical Illuminance on floor

D	C	F.C.	L	W
2	3.5	178	7.2	2.5
3	5.2	79	10.8	3.8
4	6.9	44	14.4	5.0
5	8.7	28	18.0	6.3

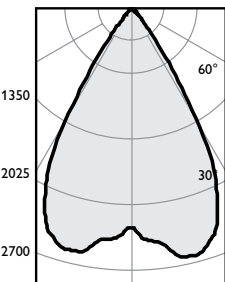

Flood (RWF)

3DTHL RWF 3.0 930 2300lm

CCT ¹ :	3000K
Output lumens:	2493 lms
Input watts ² :	19.6 W
Efficacy:	127.2 lm/w
CRI:	90 min
CBCP:	2,415 cd

Beam Angle: 59°
Cat No: 2300

30° Aiming Angle

Horizontal Illuminance on floor

D	C	F.C.	L	W
6	3.5	44	10.1	7.8
8	4.6	25	13.5	10.5
10	5.8	16	16.9	13.1
12	6.9	11	20.3	15.7

30° Aiming Angle

Vertical Illuminance on floor

D	C	F.C.	L	W
2	3.5	75	228.0	4.5
3	5.2	34	342.0	6.8
4	6.9	19	456.0	9.1
5	8.7	12	570.0	11.3

1. Correlated Color Temperature within specs as defined in ANSI_NEMA_ANSLG C78.377-2008: Specifications for the Chromaticity of Solid State Lighting Products.

2. Wattage controlled to within +/- 5%.

Note: Tested using absolute photometry as specified in LM79: IESNA Approved Method for the Electrical and Photometric Measurements of Solid-State Lighting Products.